



Grayhill, Inc.

## 62S11-M5-020CH

Número de peça:

62S11-M5-020CH

Fabricant / Marca:

Grayhill, Inc.

Descripció del producte

ROTARY ENCODER OPTICAL 32PPR

Fulls de dades:

 62S11-M5-020CH.pdf

Estat RoHs

 Sin plomo / RoHS Cumple con

Envia des de

Hong Kong

Forma d'enviament

DHL/Fedex/TNT/UPS/EMS

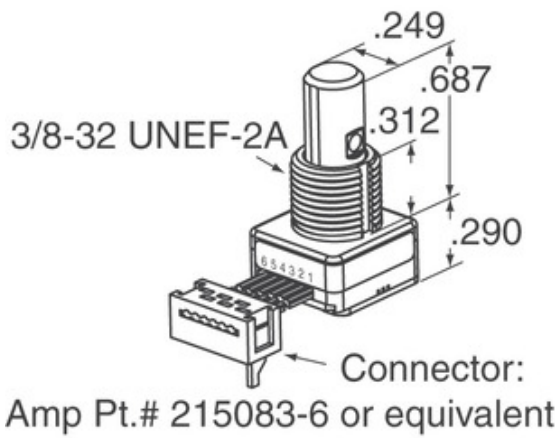

La imatge pot ser representació. Consulteu les especificacions per a detalls del producte.

[SOL · LICITUD DE PRESSUPOST](#)







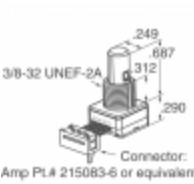

### Especificacions de 62S11-M5-020CH

NÚMERO DE PEÇA	62S11-M5-020CH
FABRICANT	Grayhill, Inc.
DESCRIPCIÓ	ROTARY ENCODER OPTICAL 32PPR
ESTAT LLIURE DE PLOM / ESTAT ROHS	Sin plomo / RoHS Cumple con
FITXA DE DADES	 62S11-M5-020CH.pdf
VOLTAGE - SUBMINISTRACIÓN	5V
ESTILO DE TERMINACIÓN	Cable with Connector
SERIE	62S
VIDA ROTACIONAL (CICLOS MÍNIMOS)	1M
GRAMÍNEAS POR REVOLUCIÓN	32
TIPO DE SAÍDA	Quadrature (Incremental)
OUTROS NOMES	62S11M5020CH
ORIENTACIÓN	Vertical
TIPO DE MONTAJE	Panel Mount
NIVEL DE SENSIBILIDADE Á HUMIDADE (MSL)	1 (Unlimited)
TEMPO DE ENTREGA ESTÁNDAR DO FABRICANTE	8 Weeks
ESTADO LIBRE DE CHUMBO / ESTADO ROHS	Lead free / RoHS Compliant
TIPO DE CODIFICADOR	Optical
DETENCIÓN	Yes
BUILT IN SWITCH	Yes
TIPO DE ACTUADOR	1/4" Dia Flatted End

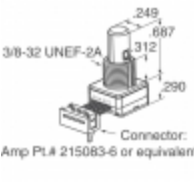
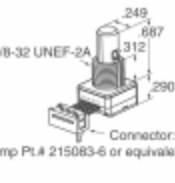
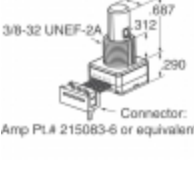
### Etiquetes relacionades

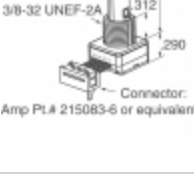
Grayhill, Inc. 62S11-M5-020CH	Distribuidor 62S11-M5-020CH	Proveïdor 62S11-M5-020CH
Preu 62S11-M5-020CH	Quadres 62S11-M5-020CH	Imatge 62S11-M5-020CH
Fitxa de dades PDF 62S11-M5-020CH	Fitxa de descàrrega 62S11-M5-020CH	Fitxa de dades 62S11-M5-020CH
Estoc 62S11-M5-020CH	Compra 62S11-M5-020CH	Comprar Grayhill, Inc. 62S11-M5-020CH
Grayhill, Inc. 62S11-M5-020CH	Proveïdor Grayhill, Inc.	Distribuidor Grayhill, Inc.
Grayhill, Inc. 62S11-M5-020CH	Grayhill Inc. 62S11-M5-020CH	

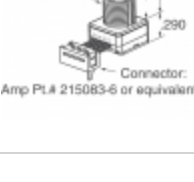
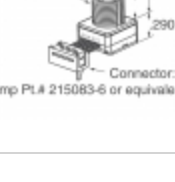
### Productes relacionats

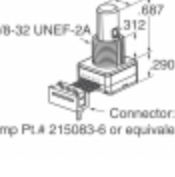
 <p><b>62S11-M5-040C</b> Fabricants: Grayhill, Inc. Descripció: ROTARY ENCODER OPTICAL 32PPR En estoc: Out stock</p> <p><a href="#">RFQ</a></p>	 <p><b>62S11-M5-020C</b> Fabricants: Grayhill, Inc. Descripció: ROTARY ENCODER OPT 32PPR 2" CBL En estoc: Out stock</p> <p><a href="#">RFQ</a></p>
 <p><b>62S11-M0-PV</b> Fabricants: Grayhill, Inc. Descripció: ROTARY ENCODER OPTICAL 32PPR En estoc: Out stock</p> <p><a href="#">RFQ</a></p>	 <p><b>62S11-M5-030CH</b> Fabricants: Grayhill, Inc. Descripció: ROTARY ENCODER OPTICAL 32PPR En estoc: Out stock</p> <p><a href="#">RFQ</a></p>
 <p><b>62S11-M0-200S</b> Fabricants: Grayhill, Inc. Descripció: ROTARY ENCODER OPTICAL 32PPR En estoc: Out stock</p> <p><a href="#">RFQ</a></p>	 <p><b>62S11-M5-050C</b> Fabricants: Grayhill, Inc. Descripció: ROTARY ENCODER OPT 32PPR 5" CBL En estoc: 558 pcs</p> <p><a href="#">RFQ</a></p>
 <p><b>62S11-M5-030C</b> Fabricants: Grayhill, Inc. Descripció: ROTARY ENCODER OPTICAL 32PPR En estoc: Out stock</p> <p><a href="#">RFQ</a></p>	 <p><b>62S11-M0-210SH</b> Fabricants: Grayhill, Inc. Descripció: ROTARY ENCODER OPT 32PPR 20" CBL En estoc: Out stock</p> <p><a href="#">RFQ</a></p>
 <p><b>62S11-M5-020S</b> Fabricants: Grayhill, Inc. Descripció: ROTARY ENCODER OPTICAL 32PPR En estoc: Out stock</p> <p><a href="#">RFQ</a></p>	 <p><b>62S11-M5-020SH</b> Fabricants: Grayhill, Inc. Descripció: ROTARY ENCODER OPT 32PPR 2" CBL En estoc: Out stock</p> <p><a href="#">RFQ</a></p>
 <p><b>62S11-M0-P</b> Fabricants: Grayhill, Inc. Descripció: ROTARY ENCODER OPTICAL 32PPR En estoc: Out stock</p> <p><a href="#">RFQ</a></p>	 <p><b>62S11-M0-PH</b> Fabricants: Grayhill, Inc. Descripció: ROTARY ENCODER OPTICAL 32PPR En estoc: Out stock</p> <p><a href="#">RFQ</a></p>