



Grayhill, Inc.

62S11-H9-060SH

Número de peça:

62S11-H9-060SH

Fabricant / Marca:

Grayhill, Inc.

Descripció del producte

ROTARY ENCODER OPTICAL 32PPR

Fulls de dades:

 62S11-H9-060SH.pdf

Estat RoHs

 Sin plomo / RoHS Cumple con

Envia des de

Hong Kong

Forma d'enviament

DHL/Fedex/TNT/UPS/EMS

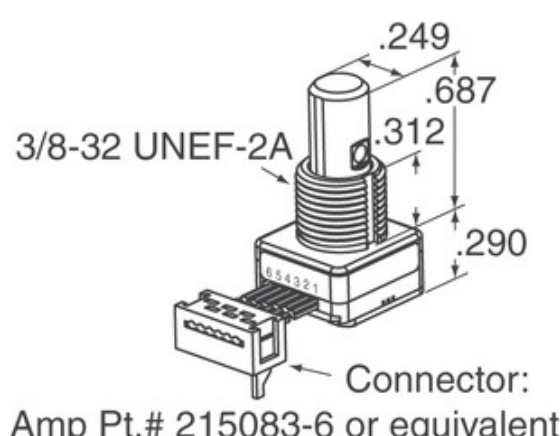

La imatge pot ser representació. Consulteu les especificacions per a detalls del producte.

SOL · LICITUD DE PRESSUPOST



Especificacions de 62S11-H9-060SH

NÚMERO DE PEÇA	62S11-H9-060SH
FABRICANT	Grayhill, Inc.
DESCRIPCIÓ	ROTARY ENCODER OPTICAL 32PPR
ESTAT LLIURE DE PLOM / ESTAT ROHS	Sin plomo / RoHS Cumple con
FITXA DE DADES	 62S11-H9-060SH.pdf
VOLTAGE - SUBMINISTRACIÓN	5V
ESTILO DE TERMINACIÓN	Cable Leads
SERIE	62S
VIDA ROTACIONAL (CICLOS MÍNIMOS)	1M
GRAMÍNEAS POR REVOLUCIÓN	32
TIPO DE SAÍDA	Quadrature (Incremental)
OUTROS NOMES	62S11H9060SH
ORIENTACIÓN	Vertical
TIPO DE MONTAJE	Panel Mount
NIVEL DE SENSIBILIDADE Á HUMIDADE (MSL)	1 (Unlimited)
TEMPO DE ENTREGA ESTÁNDAR DO FABRICANTE	8 Weeks
ESTADO LIBRE DE CHUMBO / ESTADO ROHS	Lead free / RoHS Compliant
TIPO DE CODIFICADOR	Optical
DETENCIÓN	Yes
BUILT IN SWITCH	Yes
TIPO DE ACTUADOR	1/4" Dia Flatted End

**Etiquetes
relacionades**

Grayhill, Inc. 62S11-H9-060SH	Distribuidor 62S11-H9-060SH	Proveedor 62S11-H9-060SH
Preu 62S11-H9-060SH	Quadres 62S11-H9-060SH	Imatge 62S11-H9-060SH
Fitxa de dades PDF 62S11-H9-060SH	Fitxa de descàrrega 62S11-H9-060SH	Fitxa de dades 62S11-H9-060SH
Estoc 62S11-H9-060SH	Compra 62S11-H9-060SH	Comprar Grayhill, Inc. 62S11-H9-060SH
Grayhill, Inc. 62S11-H9-060SH	Proveedor Grayhill, Inc.	Distribuidor Grayhill, Inc.
Grayhill, Inc. 62S11-H9-060SH	Grayhill Inc. 62S11-H9-060SH	

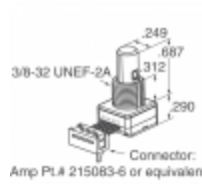
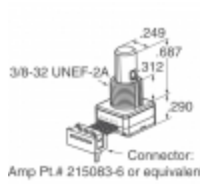
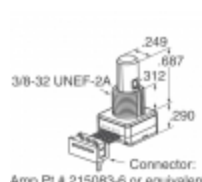
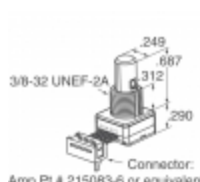
Productes relacionats

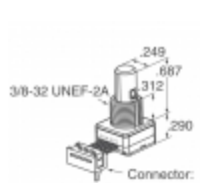
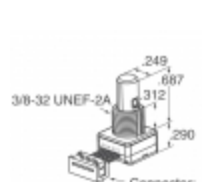
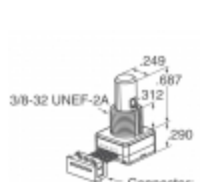
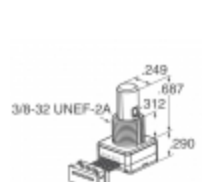
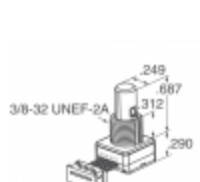
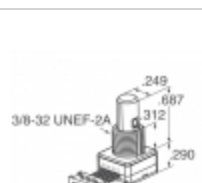
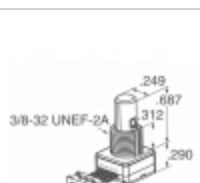
 <p>62S11-L0-040C Fabricants: Grayhill, Inc. Descripció: ROTARY ENCODER OPTICAL 32PPR En estoc: Out stock</p> <p>RFQ</p>	 <p>62S11-H9-050S Fabricants: Grayhill, Inc. Descripció: ROTARY ENCODER OPTICAL 32PPR En estoc: Out stock</p> <p>RFQ</p>
 <p>62S11-L0-020C Fabricants: Grayhill, Inc. Descripció: ROTARY ENCODER OPTICAL 32PPR En estoc: Out stock</p> <p>RFQ</p>	 <p>62S11-L0-020CH Fabricants: Grayhill, Inc. Descripció: ROTARY ENCODER OPTICAL 32PPR En estoc: Out stock</p> <p>RFQ</p>
 <p>62S11-L0-040S Fabricants: Grayhill, Inc. Descripció: ROTARY ENCODER OPT 32PPR 4" CBL En estoc: Out stock</p> <p>RFQ</p>	 <p>62S11-H9-040S Fabricants: Grayhill, Inc. Descripció: ROTARY ENCODER OPTICAL 32PPR En estoc: Out stock</p> <p>RFQ</p>
 <p>62S11-H9-020S Fabricants: Grayhill, Inc. Descripció: ROTARY ENCODER OPTICAL 32PPR En estoc: Out stock</p> <p>RFQ</p>	 <p>62S11-H9-P Fabricants: Grayhill, Inc. Descripció: ROTARY ENCODER OPTICAL 32PPR En estoc: Out stock</p> <p>RFQ</p>
 <p>62S11-H9-PH Fabricants: Grayhill, Inc. Descripció: ROTARY ENCODER OPTICAL 32PPR En estoc: Out stock</p> <p>RFQ</p>	 <p>62S11-H9-025S Fabricants: Grayhill, Inc. Descripció: ROTARY ENCODER OPTICAL 32PPR En estoc: Out stock</p> <p>RFQ</p>
 <p>62S11-H9-060C Fabricants: Grayhill, Inc. Descripció: ROTARY ENCODER OPTICAL 32PPR En estoc: Out stock</p> <p>RFQ</p>	 <p>62S11-H9-040C Fabricants: Grayhill, Inc. Descripció: ROTARY ENCODER OPTICAL 32PPR En estoc: Out stock</p> <p>RFQ</p>